

Abstreifer für TYP 360
Ø113 - Ø123

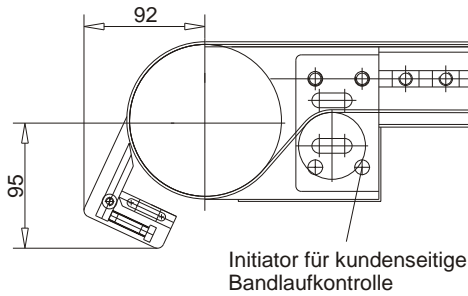

Abstreifer für TYP 362-366
Ø100

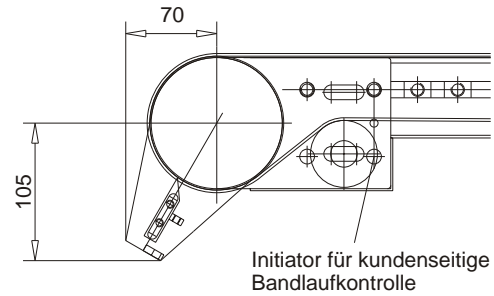

Leitbleche NB 50 und 100

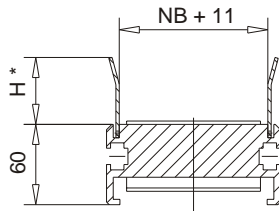

* H= 30 / 50 / 100

Leitbleche ab NB 150

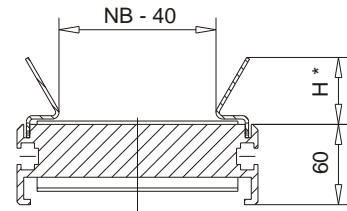

* H= 30 / 50 / 100

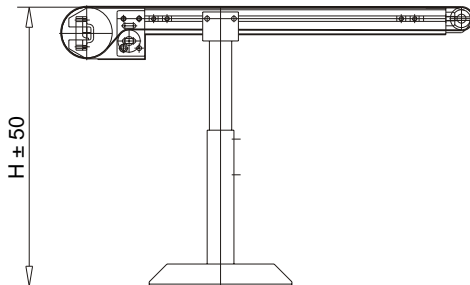

Abstützung Typ 1

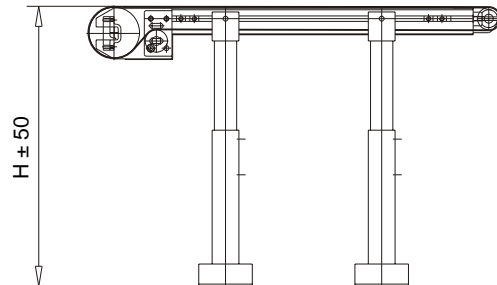

Abstützung Typ 2

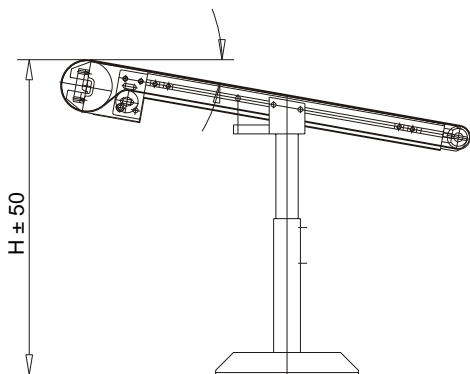

Abstützung Typ 3

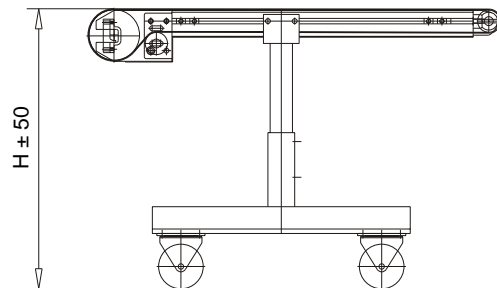

Abstützung Typ 4